

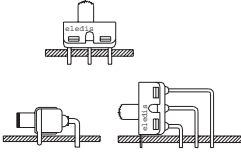

SERIES 7A

- Slide switches



AGENCY APPROVALS

RU File N° E195524
C RU File N° E195524

CHARACTERISTICS

- Snap action mechanics for long life.
- Miniature.
- Numerous optional mountings.

SPECIFICATIONS

Contact Rating: **S** (silver) - 5A @ 120 VAC or 28 VDC - 2A with resistive load @ 250 VAC - **A** (gold) - 0.4 VA @ 20 VAC or DC max - **G** (gold on silver)
Electrical life: 30,000 actuations at full load
Contact Resistance: 10 mΩ max. initial
Insulation Resistance: 1000 MΩ min.
Dielectric Strength: 1500 VRMS @ sea level
Operating Temperature: -30°C to 85°C

MATERIALS

Case: dially phthalate (DAP)
Housing: Stainless steel
Slide handle: Nylon
Contacts: Coin silver, silver plated
Center Contact & Terminals: Copper alloy, silver plated

SLIDE SWITCHES

HOW TO ORDER

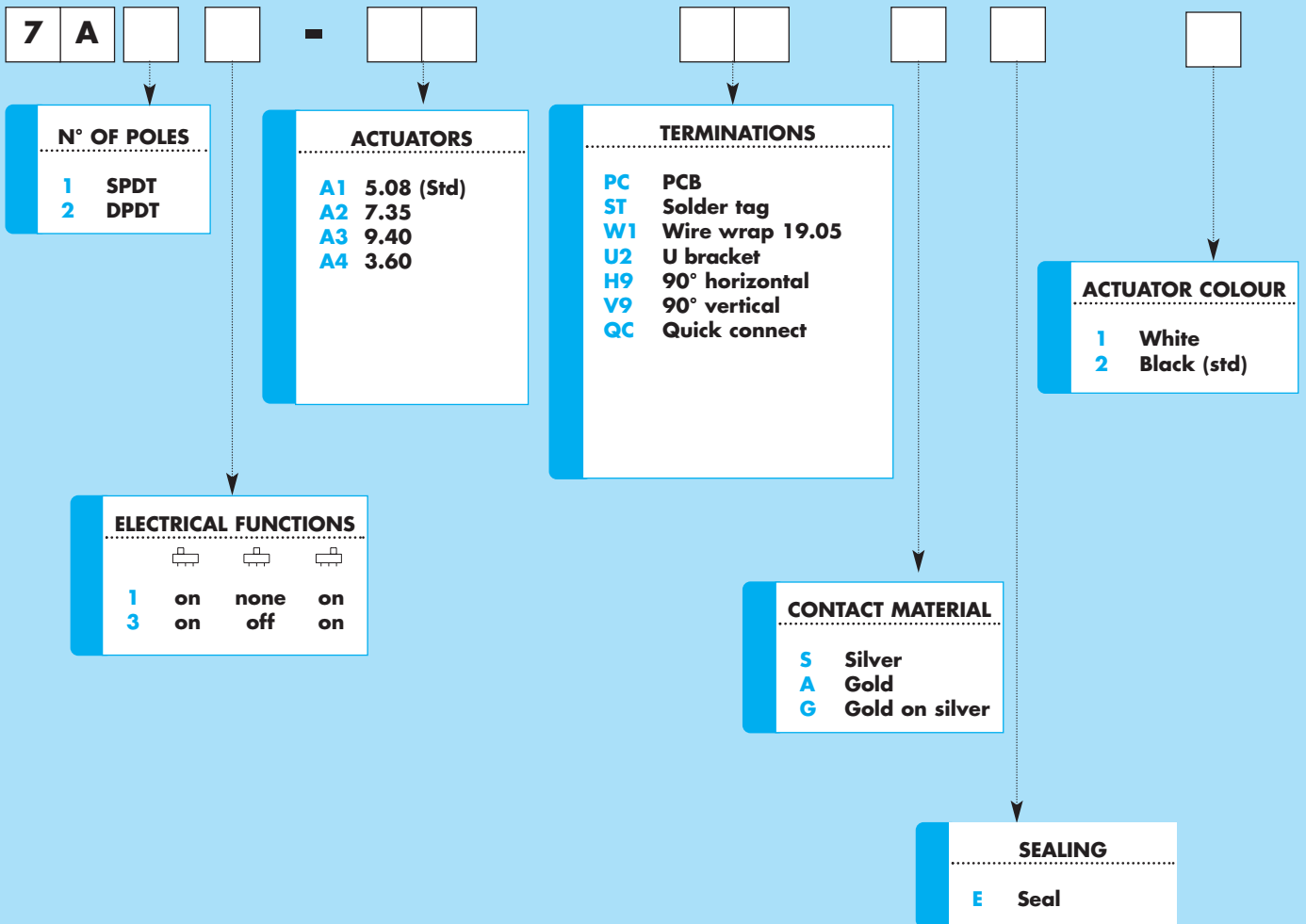

SERIES 7A

ELECTRICAL FUNCTIONS

DIMENSIONS

SPDT	Type		
1	on	none	on
3	on	off	on
	2-1	open	2-3

2 Comm.

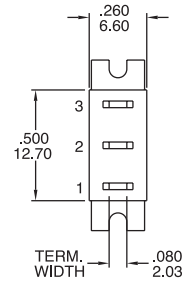
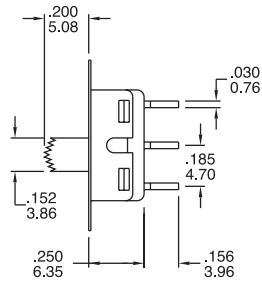
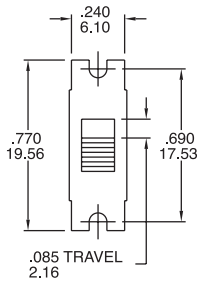

Part N° shown: 7A11-A1STSE2

DPDT	Type		
1	on	none	on
3	on	off	on
	2-1,5-4	open	2-3,5-6

2 Comm. 5 Comm.

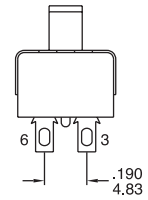
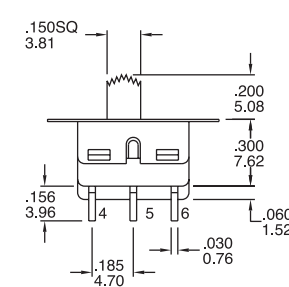
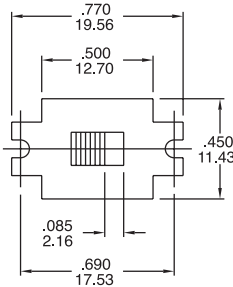

Part N° shown: 7A21-A1STSE2

ACTUATORS

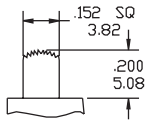

A1 (Std)

Standard Supply Black

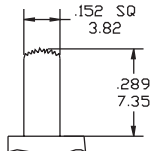

A2

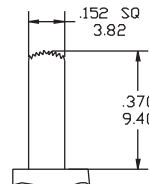

A3

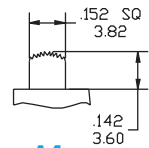

A4

TERMINATIONS

ST

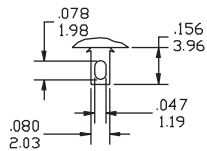

THK 0.76 (.030)

PC

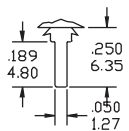

THK 0.76 (.030)

QC

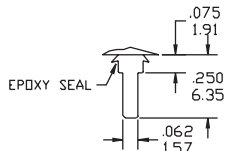

THK 0.76 (.030)

W1

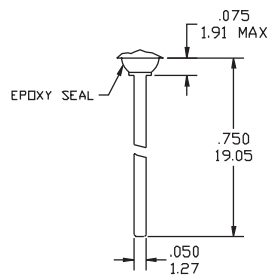

THK 0.76 (.030)



SERIES 7A

TERMINATIONS

H9
SPDT

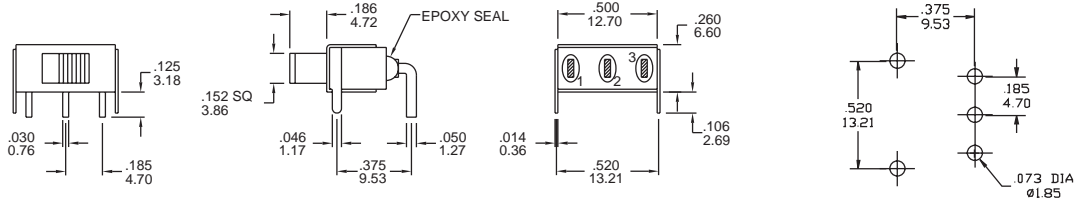

Part N° shown: 7A11-A1H9AE2

H9
DPDT

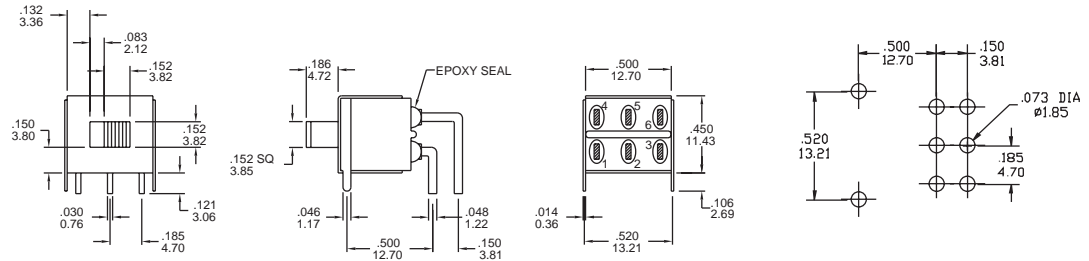

Part N° shown: 7A21-A1H9AE2

V9
SPDT

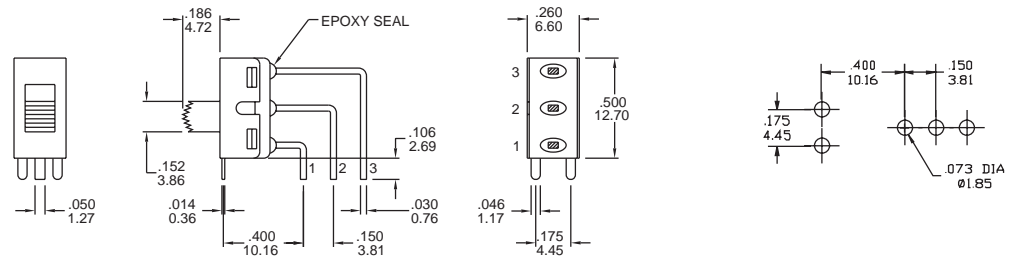

Part N° shown: 7A11-A1V9AE2

V9
DPDT

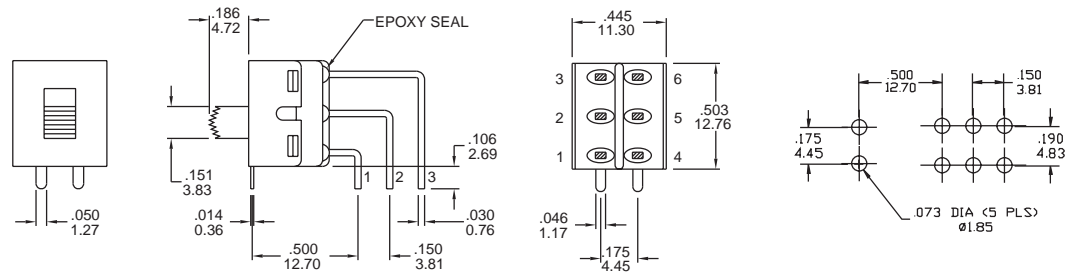

Part N° shown: 7A21-A1V9AE2

SERIES 7A

TERMINATIONS

U2 SPDT

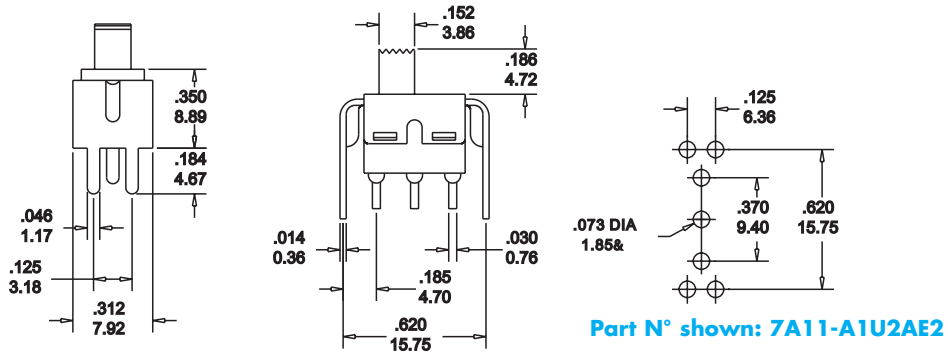

U2 DPDT

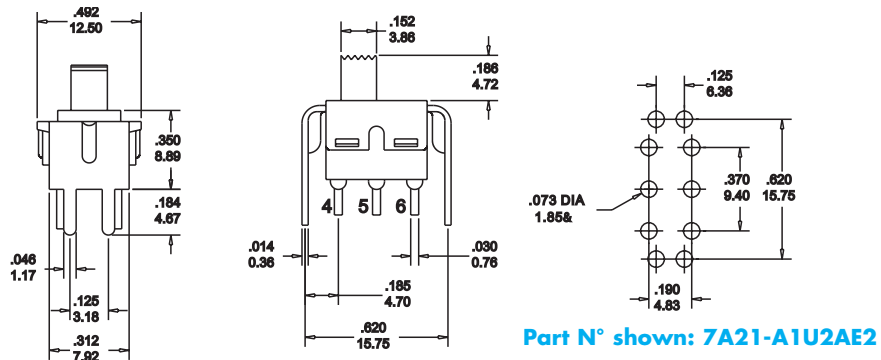

CONTACT MATERIALS

CONTACT RATINGS

- S** **Moving Contacts:** coin silver
Terminals: copper alloy, silver plated
Rating: 2 Amps with resistive load @ 250 VAC
5 Amps with resistive load @ 125 VAC or 28 VDC
- A** **Moving Contacts:** copper alloy with gold plating over nickel plating
Terminals: copper alloy with gold plating over nickel plating
Rating: 0.4 Volts/Amps max @ 20 Volts max (AC or DC)
- G** **Moving Contacts:** gold plating over silver
End Terminals: gold plating over silver
Center Terminals: gold plating over copper alloy, silver plated
Note: G option used for either "high" (2 Amps @ 250 VAC) or "low" (0.4 Volts/Amps max) contact rating (one exclude the other)

PACKAGING

Transparent Trays 15x21x4 cm



Each box contains
Series 7A1x 400 pcs
7A2x 200 pcs

MARKING (on products)

The switches are individually marked with the following information:

- Side 1** TRADE MARK
SERIES AND MODEL
DATE CODE
- Side 2** RATING
CONTACTS

Note: Not all information may be available on some products.

LABELLING (on packaging)

The label on each tray gives full information on the products contained.

P/N: EL.FNC.: Q.TY: DATE CODE:	
Made in Taiwan	
Remarks	

A Bar code indicating Model, Quantity, Date Code enables easy traceability.